

The Reliable Source . . .

FERROPERM

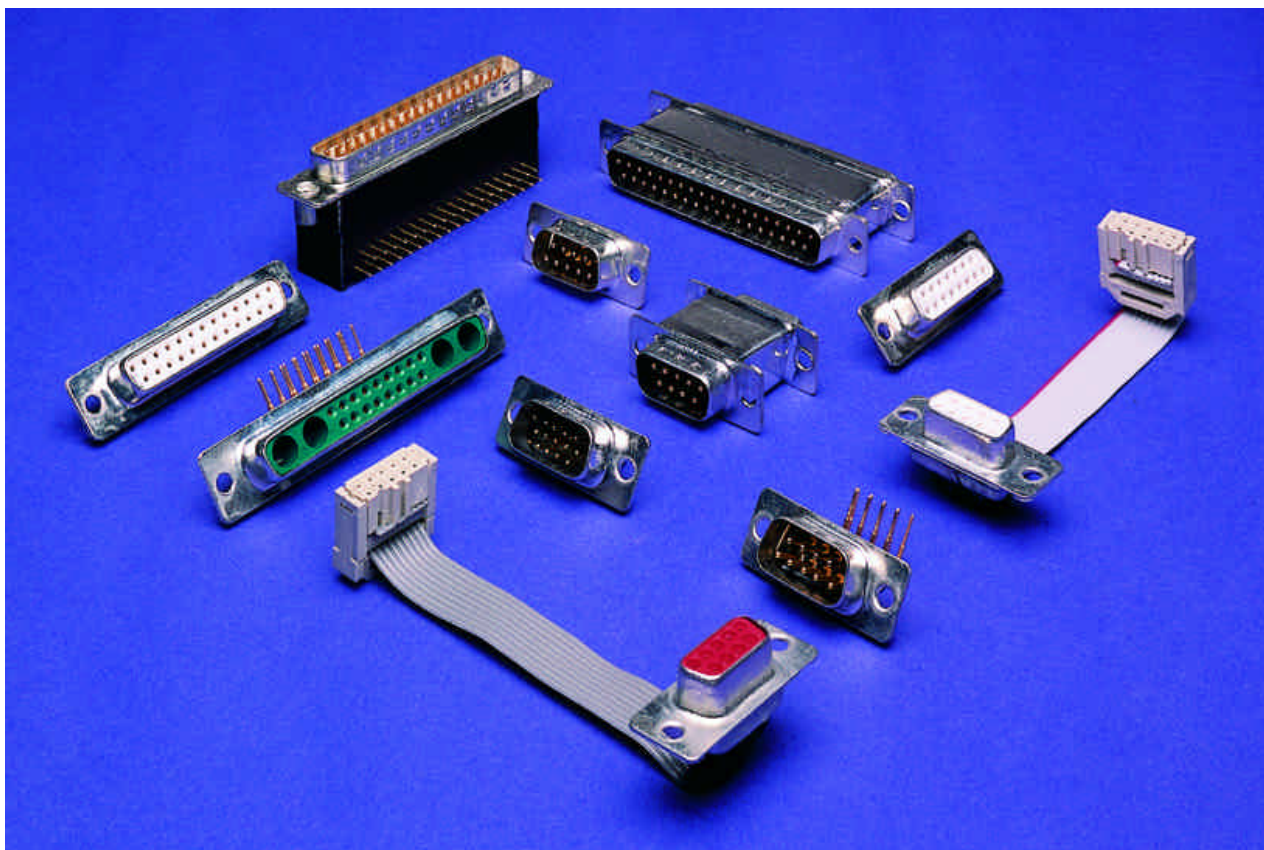

. . . for High Quality



Specialist Connectors

SPECIALIST CONNECTORS

from FERROPERM UK Ltd.

Introduction

This catalogue presents a survey of Sub-D and other specialist connectors from FERROPERM. FERROPERM produces mainly filtered connectors, drawing on its long established expertise in filter design. The scope of FERROPERM's connector production is constantly widening due to its commitment to research and development.

This brochure presents our standard ranges plus some examples of custom designs. Whatever your requirement in connectors, be it standard density, high density, mixed layout Sub-D or any other type, please ask us for a quotation. Filter options include feedthrough capacitors, Pi-filters and ferrites.

Selective filtering with a mixture of different filters in the same connector are produced. Pins can be grounded or omitted altogether for keying. We can also supply various fixing options and mounting gaskets.

Pp 3-5.	Standard Density Sub-Ds with 1nF per contact - Standard production items.
pp 6-7.	16 SD 10 & 11 Sub-D Adaptors with feedthrough capacitors and Pi-filters - Standard production items.
pp 8-17.	16 SC 3, 4 & 16 SD 7, 52, 57, 88, 89, 90 & 92 - Examples of custom designs.

CUSTOM CONNECTORS

If you would like us to design a filtered (or otherwise special) connector to meet your requirements, please send us the following information. If you do not have all the information available, please just give what you can.

1. Specify the application.
 2. If you have a preference for a particular hardware design (for example Sub-D), please state it. Otherwise, specify the maximum dimensions of the space you have available for the connector.
 3. Specify any special physical requirements you may have for the connector. For instance, you might want IP64 rating or an explosion proof design.
 4. Specify your estimated requirements of quantities and delivery dates both for short term and long term. This is important because it may influence what hardware is specified for the design.
 5. If you have a target or maximum price level, please state it.
 6. If you are not specifying the connector hardware, please specify the currents flowing in all circuits of the connector. Give as much detail as you can.
 7. EITHER: Specify minimum required impedance at particular frequencies or sketch a graph of minimum required impedance versus frequency. Do this for all circuits of the connector.
OR: Specify what filter elements (for instance, 1nF capacitors) you require on each circuit of the connector.
 8. Specify working voltages. Give as much detail as you can.
-

Whilst every care was taken to avoid any mistakes in the compilation of this catalogue, no responsibility can be assumed for any errors which may have occurred in it. In line with Ferroperm's policy of continual development, Ferroperm reserves the right to alter specifications of any products without notice.

FERROPERM

SUB-D FILTER CONNECTORS

GENERAL SPECIFICATIONS

SUB D connectors with built-in capacitors, which provide excellent attenuation of EMI and RFI.

The connectors are available with 9,15,25 or 37 ways, plug or socket, in solderbucket, Straight - PC or 90 degree versions.

Contacts.....	Gold plated turned copper alloy.
Shell.....	Tin plated steel (plugs have contact dimples).
Minimum number of insertions....	500.
Contact resistance	max. 10 mΩ.
Current rating	5A.
Working voltage	100V.
Capacitance	1 nF (other values available on request).
Tolerance of capacitance	-20/+80%
Temperature range	-55 °C to 85 °C.

Part numbers for these connectors are listed 2 pages on.

Typical Loss vs. Frequency (50 ohm line)

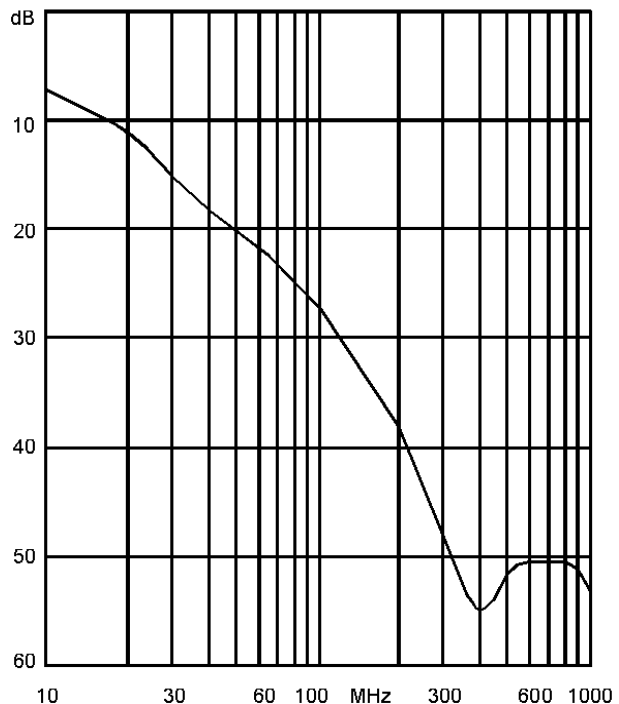

NEW !

50-way versions now available.

Please enquire for details.

FERROPERM

SUB-D FILTER CONNECTORS

GENERAL SPECIFICATIONS

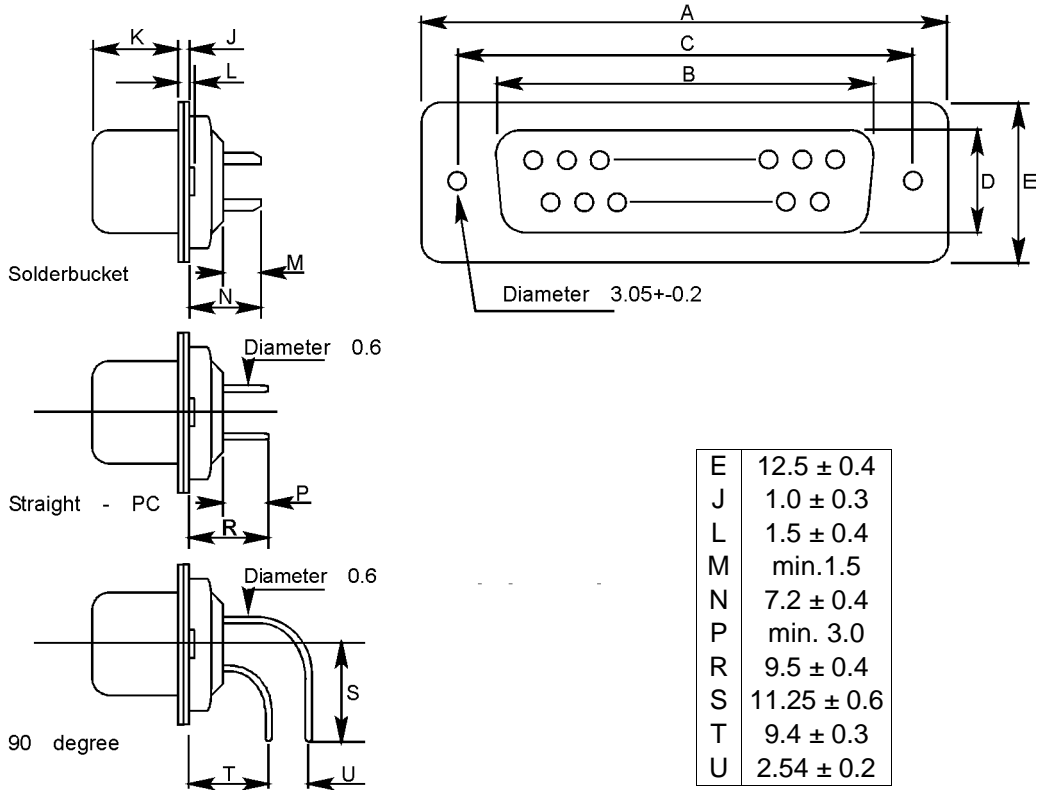

All dimensions in mm. Do Not Scale.

WAYS		A ± 0.4	B ± 0.3	C ± 0.2	D ± 0.3	K ± 0.3
9.0	Plug	30.8	17.7	25.0	9.1	6.0
	Socket		16.3		7.8	6.2
15.0	Plug	39.1	26.0	33.3	9.1	6.0
	Socket		24.6		7.8	6.2
25.0	Plug	53.0	40.2	47.0	9.6	5.9
	Socket		38.3		7.8	6.2
37.0	Plug	69.3	56.7	63.5	9.6	5.9
	Socket		54.8		7.8	6.2

FERROPERM

SUB-D FILTER CONNECTORS

PART NUMBERS

To order these connectors, just specify the part number from the left hand column. For example, if you want a 15-way straight-PC socket, order part number B-2FC15S1.

Old Part Number	Part Number	No of ways and capacitance	Mounting style	Type
16 SD 12	B-2FC09P	9x1nF -20+80%	Solder Bucket	plug
16 SD 13	B-2FC09S	9x1nF -20+80%	Solder Bucket	socket
16 SD 14	B-2FC15P	15x1nF -20+80%	Solder Bucket	plug
16 SD 15	B-2FC15S	15x1nF -20+80%	Solder Bucket	socket
16 SD 16	B-2FC25P	25x1nF -20+80%	Solder Bucket	plug
16 SD 17	B-2FC25S	25x1nF -20+80%	Solder Bucket	socket
16 SD 18	B-FC37P	37x1nF -20+80%	Solder Bucket	plug
16 SD 19	B-FC37S	37x1nF -20+80%	Solder Bucket	socket
16 SD 28	B-2FC09P1	9x1nF -20+80%	Straight - PCB	plug
16 SD 29	B-2FC09S1	9x1nF -20+80%	Straight - PCB	socket
16 SD 30	B-2FC15P1	15x1nF -20+80%	Straight - PCB	plug
16 SD 31	B-2FC15S1	15x1nF -20+80%	Straight - PCB	socket
16 SD 32	B-2FC25P1	25x1nF -20+80%	Straight - PCB	plug
16 SD 33	B-2FC25S1	25x1nF -20+80%	Straight - PCB	socket
16 SD 34	B-FC37P1	37x1nF -20+80%	Straight - PCB	plug
16 SD 35	B-FC37S1	37x1nF -20+80%	Straight - PCB	socket
16 SD 36	B-2FC09P5	9x1nF -20+80%	90 degree PCB	plug
16 SD 37	B-2FC09S5	9x1nF -20+80%	90 degree PCB	socket
16 SD 38	B-2FC15P5	15x1nF -20+80%	90 degree PCB	plug
16 SD 39	B-2FC15S5	15x1nF -20+80%	90 degree PCB	socket
16 SD 40	B-2FC25P5	25x1nF -20+80%	90 degree PCB	plug
16 SD 41	B-2FC25S5	25x1nF -20+80%	90 degree PCB	socket
16 SD 42	B-FC37P5	37x1nF -20+80%	90 degree PCB	plug
16 SD 43	B-FC37S5	37x1nF -20+80%	90 degree PCB	socket

FERROPERM

SUB-D FILTER ADAPTORS

16 SD 10

These SUB-D adaptors have a plug at one end and a socket at the other. They have built-in feedthrough capacitors which provide excellent attenuation of conducted electromagnetic interference (EMI).

These adaptors are available with 9, 15, 25 or 37 ways.

Mating cycles	500	Current rating	5 A
Contacts	machined Cu alloy	Working voltage	50 Vdc
Contact plating	0.5 μ gold	Capacitance	1 nF
Shell	Tin-plated steel	Tolerance	-20 +80%
Contact resistance ..	max. 10 m Ω	Temperature	-55 °C to 85 °C

To order these adaptors, please specify 16 SD 10 XX where XX is the number of ways.(9, 15, 25 or 37)

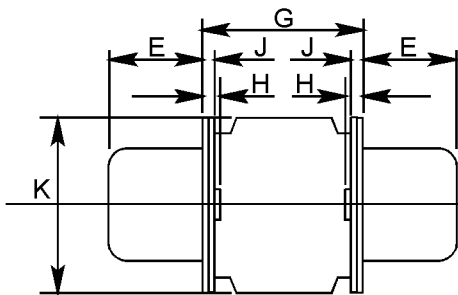

All dimensions in mm.

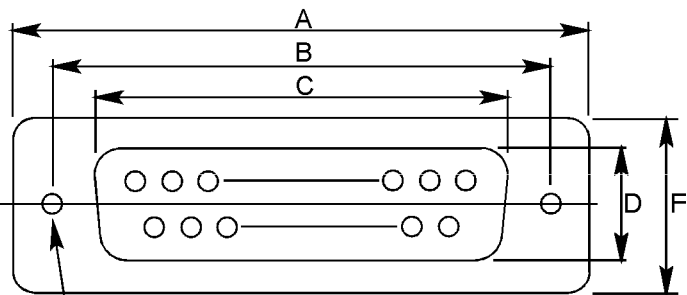

Dia. 3.05 \pm 0.2

Typical Loss vs. Frequency (50 ohm line)

Ways	9	15	25	37	
A \pm 0.4	30.8	39.1	53.0	69.3	
B \pm 0.2	25.0	33.3	47.0	63.5	
Plug	C \pm 0.3	17.1	26.0	40.2	
	D \pm 0.3	9.1			
	E \pm 0.3	6.0			
	Socket	C \pm 0.3	16.3	24.6	38.3
		D \pm 0.3	7.8		
E \pm 0.3		6.2			
F \pm 0.4		12.5			
G \pm 1.0		17.0			
H \pm 0.4	1.4				
J \pm 0.3	1.0				
K \pm 1.0	13.0				

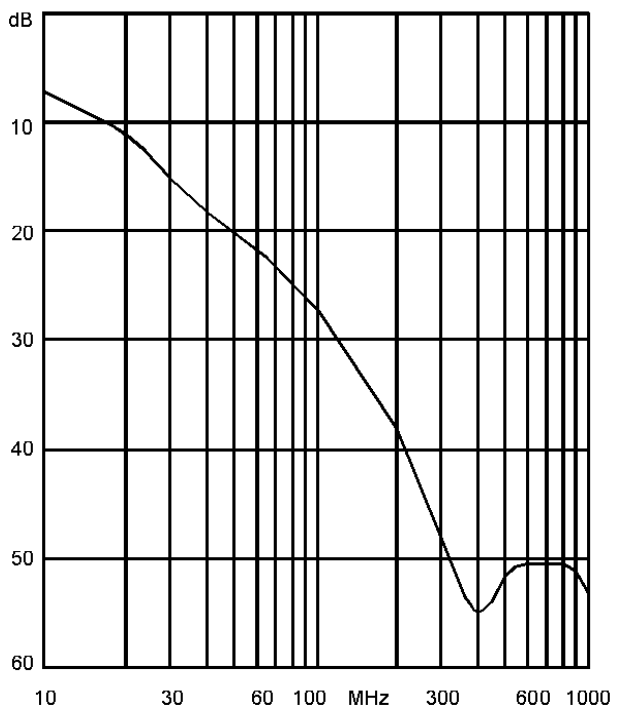

FERROPERM

SUB-D FILTER ADAPTORS

16 SD 11

These SUB-D adaptors have a plug at one end and a socket at the other. They have built-in feedthrough Pi-filters which provide excellent attenuation of conducted electromagnetic interference (EMI).

These adaptors are available with 9, 15 or 25 ways.

Mating cycles	500	Current rating	5 A
Contacts	machined Cu alloy	Working voltage	50 Vdc
Contact plating	0.5 μ gold	Capacitance	2 x 1 nF
Shell	Tin-plated steel	Tolerance	-20 +80%
Contact resistance ..	max. 10 m Ω	Temperature	-55 °C to 85 °C

To order these adaptors, please specify 16 SD 11 XX
where XX is the number of ways.(9, 15 or 25)

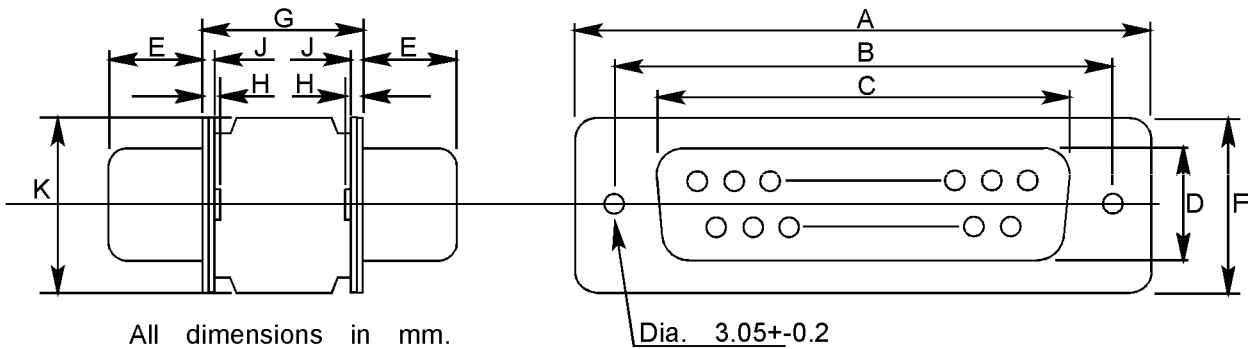

	Ways	9	15	25	
Plug	A \pm 0.4	30.8	39.1	53.0	
	B \pm 0.2	25.0	33.3	47.0	
	C \pm 0.3	17.1	26.0	40.2	
	D \pm 0.3	9.1			
	E \pm 0.3	6.0			
	Socket	C \pm 0.3	16.3	24.6	38.3
		D \pm 0.3	7.8		
		E \pm 0.3	6.2		
		F \pm 0.4	12.5		
		G \pm 1.0	17.0		
H \pm 0.4		1.4			
J \pm 0.3		1.0			
K \pm 1.0	13.0				

Typical Loss vs. Frequency (50 ohm line)

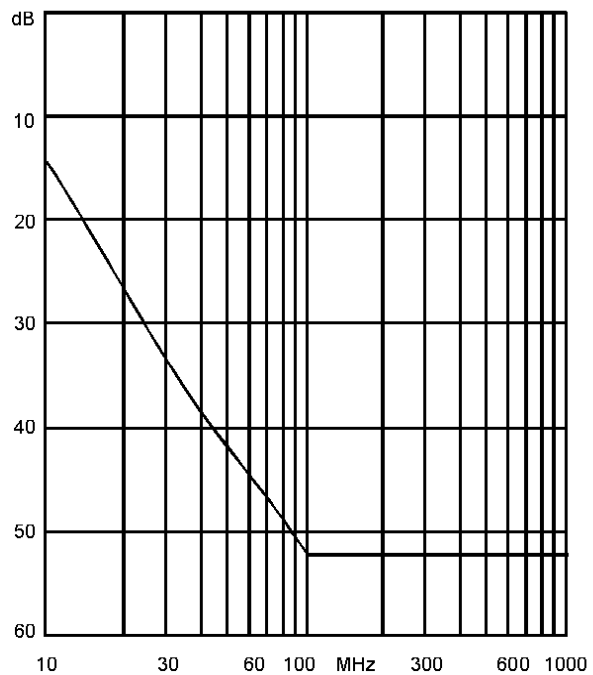

FERROPERM

SUB-D FILTER CONNECTORS

16 SC 3 & 16 SC 4

An example of a custom design

These SUB-D connectors have built-in feedthrough Pi-filters which provide excellent attenuation of conducted electromagnetic interference (EMI). 16 SC 3 (Socket) has all 9 contacts filtered. 16 SC 4 (Plug) has filters fitted to pins 4,5 & 9 only. Pins 3 & 8 are omitted. Pins 1,2,6 & 7 are unfiltered.

Mating cycles	500	Current rating	5 A
Contacts	machined Cu alloy	Working voltage	50 Vdc
Contact plating	0.5 μ gold	Capacitance	2 x 1 nF min.
Shell	Tin-plated steel	Inductance	100nH min.
Insulation resistance	min. 3 G Ω	Temperature	-55 $^{\circ}$ C to 85 $^{\circ}$ C

To order these adaptors, please specify 16 SD 3 or 16 SD 4

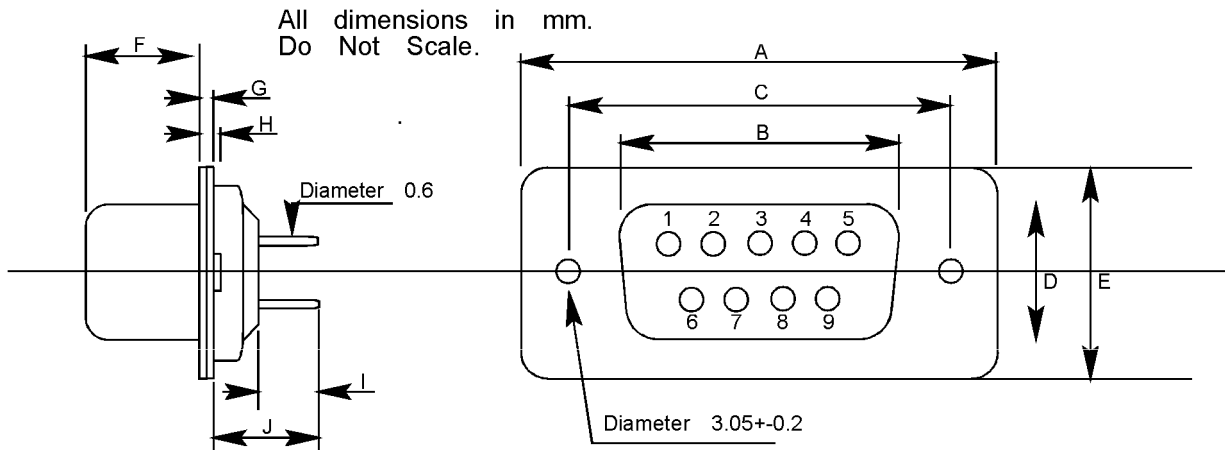

Pin Numbers shown for 16SC3 socket. They are the reverse for the 16SC4 plug. (That is, 1 becomes 5 and 6 becomes 9.)

	Plug	Socket
A \pm 0.4	30.8	30.8
B \pm 0.3	17.7	16.3
C \pm 0.2	25	25
D \pm 0.3	9.1	7.8
E \pm 0.4	12.5	12.5
F \pm 0.3	6	6.2
G \pm 0.3	1	1
H \pm 0.4	1.5	1.5
I min	8	8
J min	17	17

Typical Loss vs. Frequency (50 ohm line)

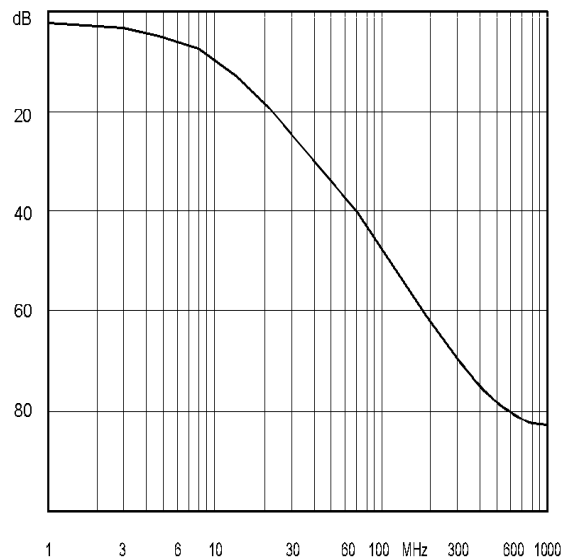

FERROPERM

SUB-D FILTER SOCKETS

16 SD 7

An example of a custom design

These SUB-D connectors have built-in feedthrough capacitors which provide excellent attenuation of conducted electromagnetic interference (EMI). The connectors have 37 ways.

Mating cycles	500	Current rating	5 A
Contacts	machined Cu alloy	Working voltage	100 Vdc
Contact plating	0.5 μ gold	Capacitance	330pF Typ
Shell	Tin-plated steel	Temperature	-55 °C to 125 °C
Contact resistance...	max. 10 m Ω		

To order these connectors, please specify 16 SD 7

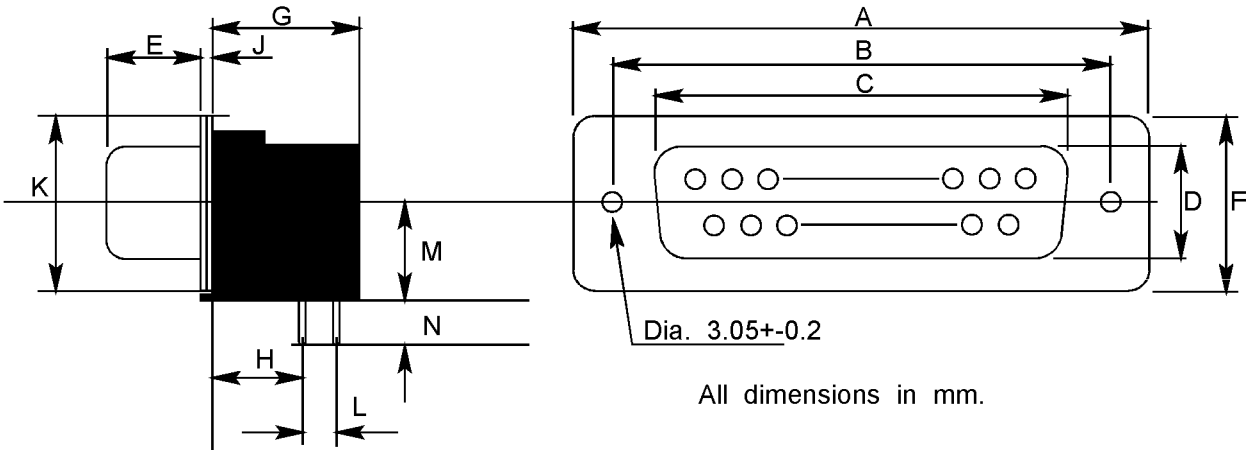

All dimensions in mm.

Typical Loss vs. Frequency (50 ohm line)

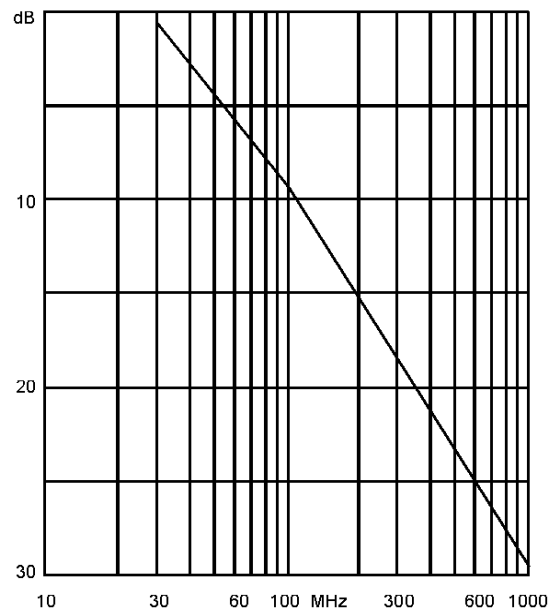

Ways	37
A \pm 0.3	69.3
B \pm 0.1	63.5
C \pm 0.2	54.75
D \pm 0.2	7.8
E \pm 0.2	6.2
F \pm 0.3	12.5

G \pm 0.2	13.7
H \pm 0.2	9.4
J \pm 0.2	0.8
K \pm 0.3	15.3
L	2.54
M \pm 0.2	7.3
N \pm 0.3	3.7

FERROPERM

SUB-D FILTER PLUGS

16 SD 52

An example of a custom design

These SUB-D connectors have 17 signal pins and have holes for 2 power/coaxial pins at each end. The signal pins have built-in feedthrough capacitors which provide excellent attenuation of conducted electromagnetic interference (EMI). The signal pins are bent to 90° in the opposite direction to the convention.

To order these connectors, please specify 16 SD 52

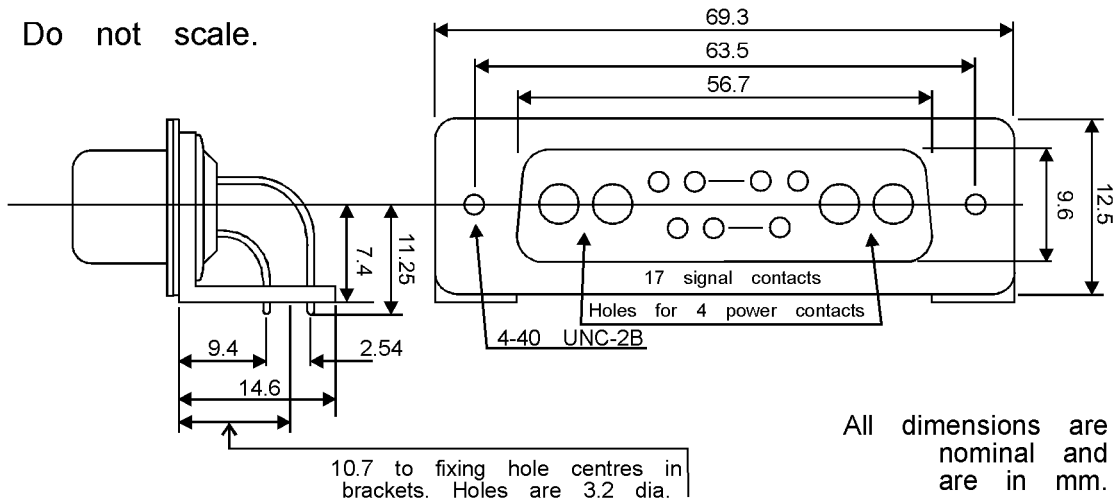

Typical Loss vs. Frequency (50 ohm line)

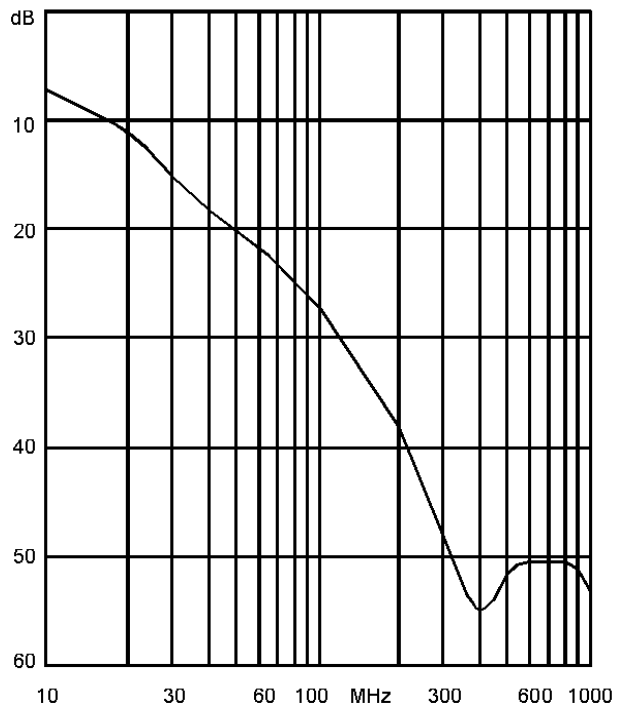

Mating cycles	500
Contacts	machined Cu alloy
Contact plating	0.5 μ gold
Shell	Tin-plated steel
Contact resistance ..	max. 10 m Ω
Current rating	5 A
Working voltage	200 Vdc
Test voltage	600 Vdc
Capacitance	1 nF
Tolerance	-20 +80%
Temperature	-55 $^{\circ}$ C to 85 $^{\circ}$ C

FERROPERM

HERMETICALLY SEALED SUB-D FILTER ADAPTORS

16 SD 57

An example of a custom design

These SUB-D adaptors have a socket at each end. One of these is hermetically sealed. They have built-in feedthrough capacitors which provide excellent attenuation of conducted electromagnetic interference (EMI). The adaptors are available with 9, 15, 25 or 37 ways. A gasket is supplied to mount this adaptor.

Mating cycles	500	Current rating	5 A
Contacts	machined Cu alloy	Working voltage	50 Vdc
Contact plating	0.5 μ gold	Capacitance	1 nF
Shell	Tin-plated steel	Tolerance	-20 +80%
Contact resistance ..	max. 10 m Ω	Temperature	-55 °C to 85 °C

To order these adaptors, please specify 16 SD 57 XX where XX is the number of ways.(9, 15, 25 or 37)

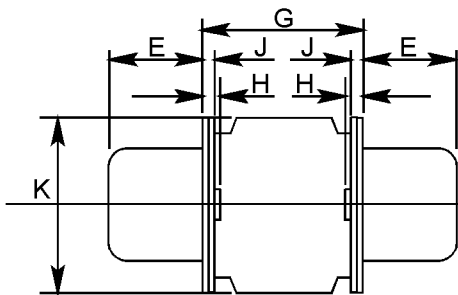

All dimensions in mm.

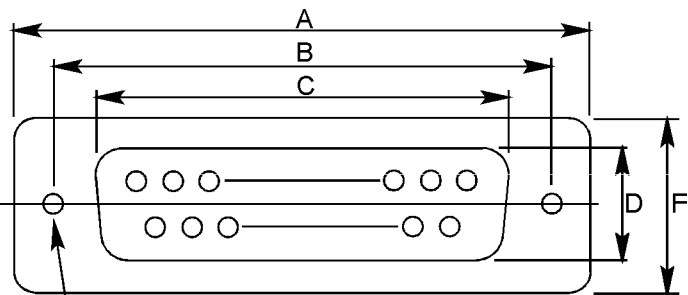

Dia. 3.05 \pm 0.2

Typical Loss vs. Frequency (50 ohm line)

Ways	9	15	25	37
A \pm 0.4	30.8	39.1	53.0	69.3
B \pm 0.2	25.0	33.3	47.0	63.5
C \pm 0.3	16.3	24.6	38.3	54.8
D \pm 0.3	7.8			
E \pm 0.3	6.2			
F \pm 0.4	12.5			
G \pm 1.0	17.0			
H \pm 0.4	1.4			
J \pm 0.3	1.0			
K \pm 1.0	13.0			

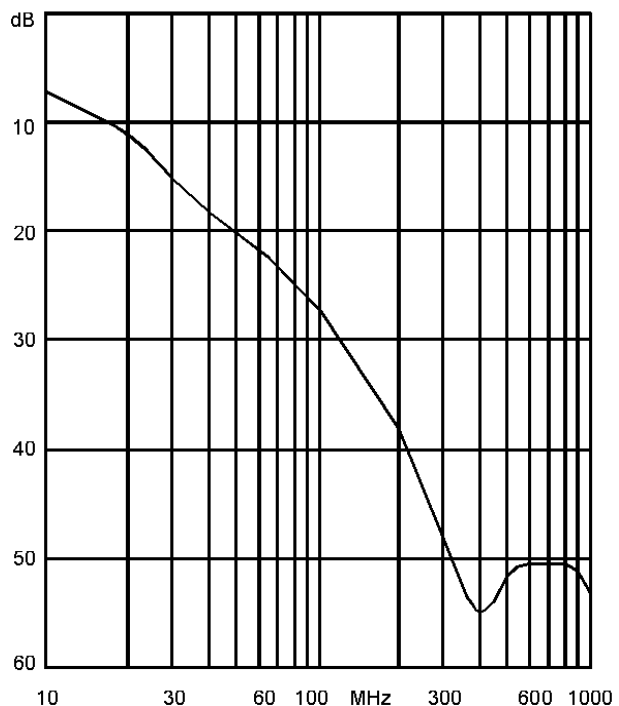

FERROPERM

HERMETICALLY SEALED SUB-D FILTER ADAPTORS

16 SD 88

An example of a custom design

These SUB-D adaptors have a socket at each end. One of these is hermetically sealed. They have built-in feedthrough capacitors which provide excellent attenuation of conducted electromagnetic interference (EMI). They have built-in transient voltage suppressors to help protect against transients caused by ESD, lightning strikes, etc. The adaptors are available with 9, 15, 25 or 37 ways. A gasket is supplied to mount this adaptor.

Mating cycles	500	Current rating	5 A
Contacts	machined Cu alloy	Working voltage	See box below.
Contact plating	0.5 μ gold	Capacitance	1 nF
Shell	Tin-plated steel	Tolerance	-20 +120%
Contact resistance ..	max. 10 m Ω	Temperature	-55 °C to 85 °C

To order these adaptors, please specify 16 SD 88 VV XX where VV is working voltage (3.6V, 5.6V, 14V, 18V, 26V, 30V or 48V) and XX is the number of ways (9, 15, 25 or 37).

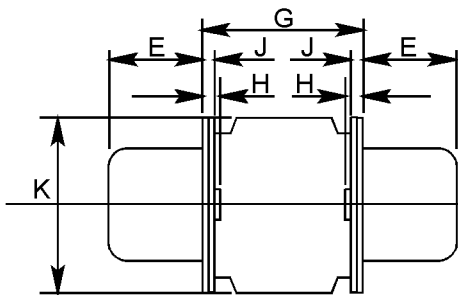

All dimensions in mm.

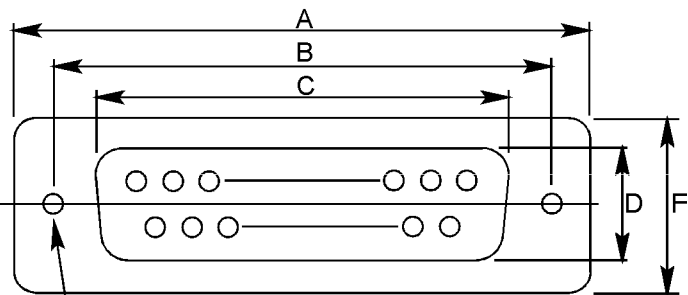

Dia. 3.05 \pm 0.2

Typical Loss vs. Frequency (50 ohm line)

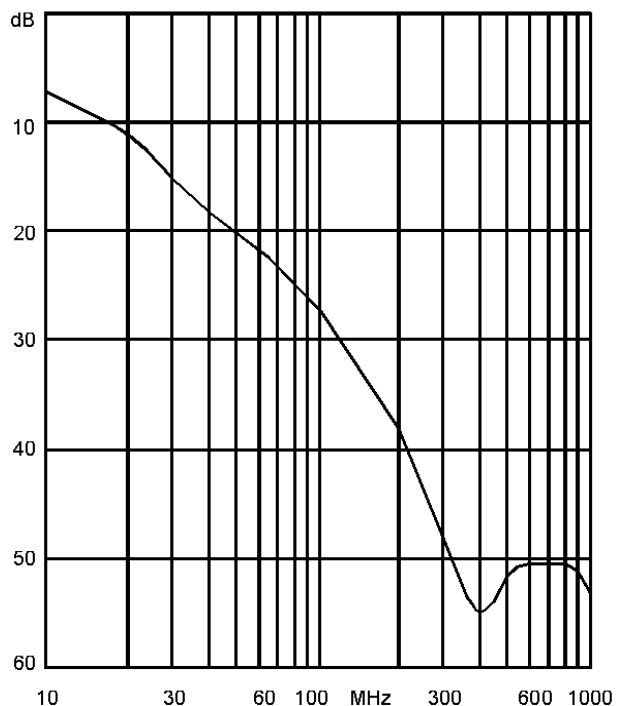

Ways	9	15	25	37	
A \pm 0.4	30.8	39.1	53.0	69.3	
B \pm 0.2	25.0	33.3	47.0	63.5	
C \pm 0.3	17.1	26.0	40.2	56.7	
D \pm 0.3	9.1				
E \pm 0.3	6.0				
Plug	C \pm 0.3	16.3	24.6	38.3	54.8
	D \pm 0.3	7.8			
Socket	E \pm 0.3	6.2			
	F \pm 0.4	12.5			
G \pm 1.0	17.0				
H \pm 0.4	1.4				
J \pm 0.3	1.0				
K \pm 1.0	13.0				

FERROPERM

HERMETICALLY SEALED SUB-D FILTER ADAPTORS

16 SD 88

An example of a custom design

Typical Voltage vs Current Curves.

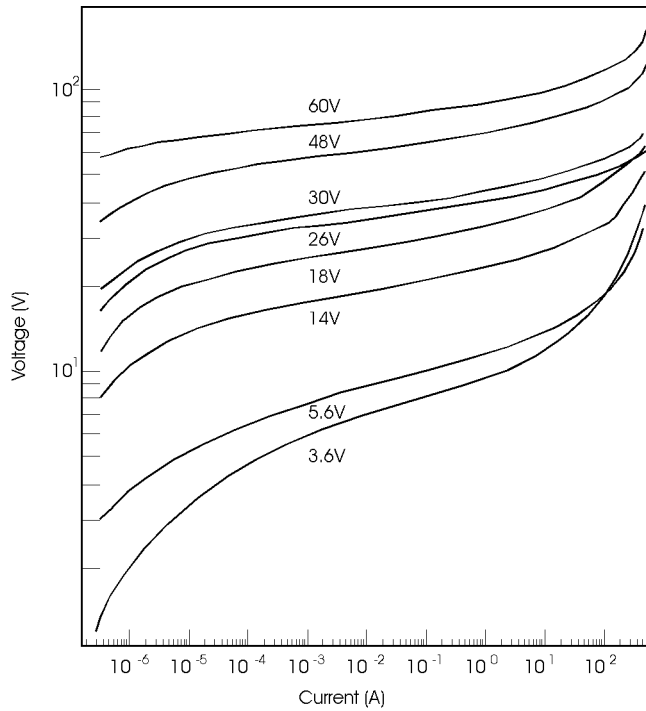

Typical Breakdown & Clamping Voltages vs Temperature.

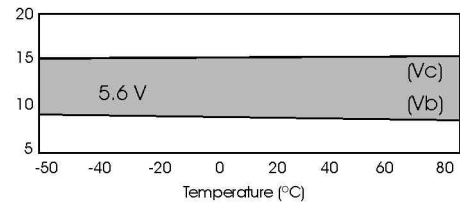
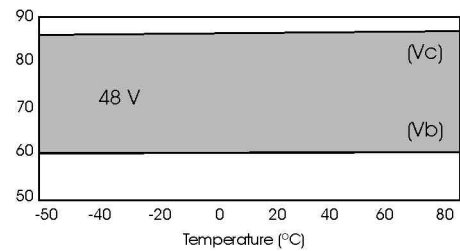
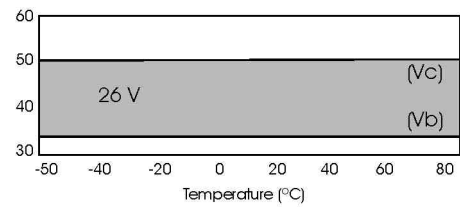
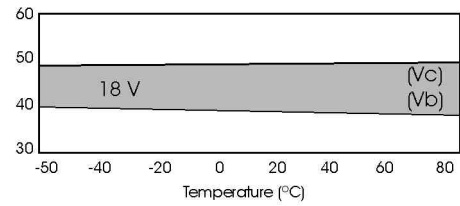

Typical Pulse Degradation for 8 x 20 μs 150A Peak Current Pulse.

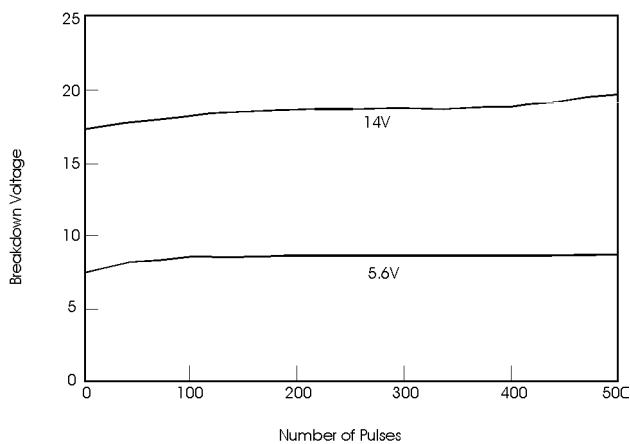

FERROPERM

SUB-D FILTER SOCKETS

16 SD 89

An example of a custom design

These SUB-D connectors have 5 signal pins and 4 power pins, all with built-in feedthrough capacitors which provide excellent attenuation of conducted electromagnetic interference (EMI). The pins are bent to 90°.

To order these connectors, please specify 16 SD 89

All dimensions are nominal and are in mm. Do not scale.

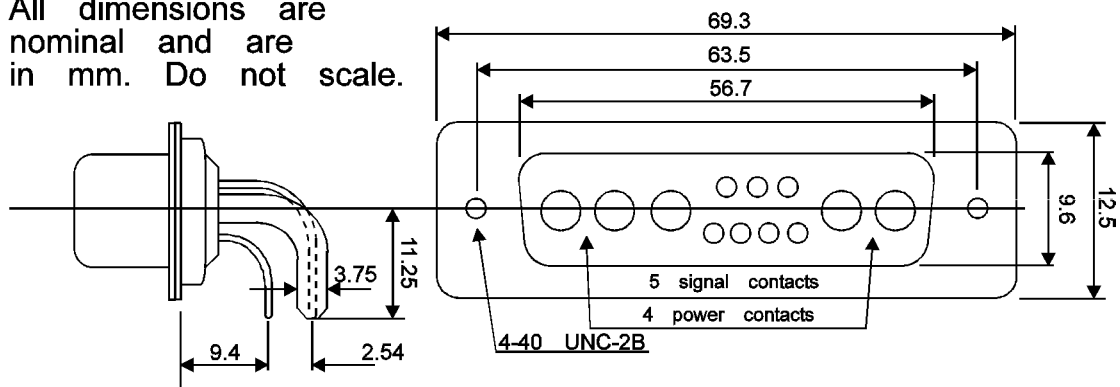

Typical Loss vs. Frequency (50 ohm line)

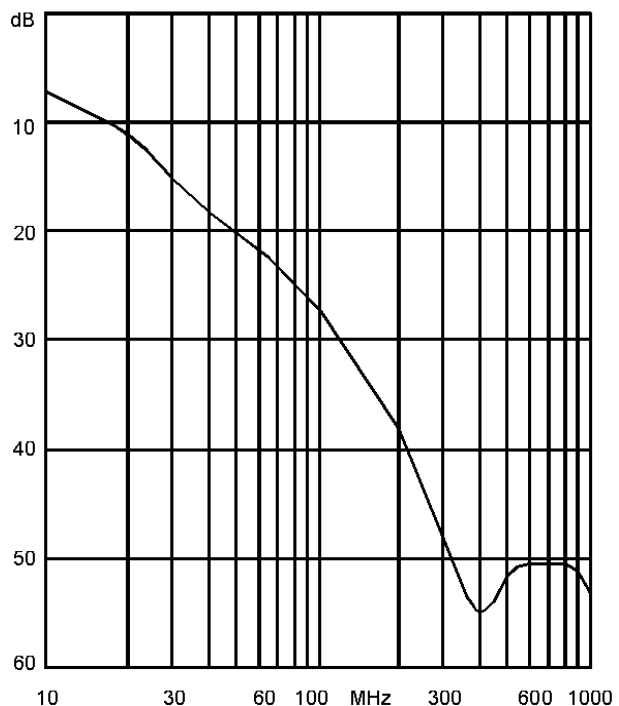

Mating cycles	500
Contacts	machined Cu alloy
Contact plating	0.5 μ gold
Shell	Tin-plated steel
Contact resistance ..	max. 10 m Ω
(Signal Pins only)	
Current rating	5 A. / 40A
(Signal/Power Pins)	
Working voltage	80 Vdc
Test voltage	240 Vdc
Capacitance	1 nF
Tolerance	-20 +80%
Temperature	-55 $^{\circ}$ C to 85 $^{\circ}$ C

FERROPERM

HIGH DENSITY SUB-D FILTER PLUGS

16 SD 90

An example of a custom design

These SUB-D connectors have built-in feedthrough capacitors which provide excellent attenuation of conducted electromagnetic interference (EMI). They are high density connectors, having 15 ways where a standard density connector would only have 9 ways.

To order these connectors, please specify 16 SD 90

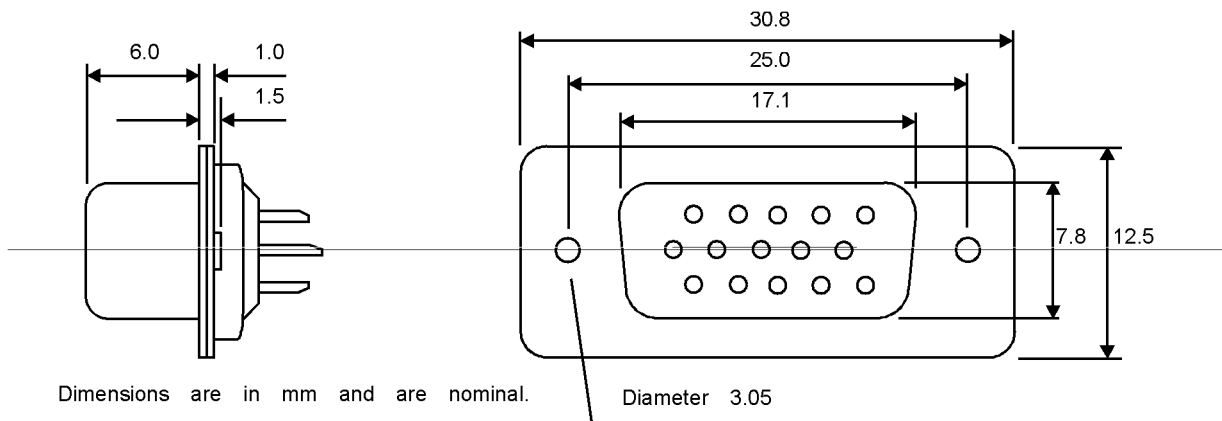

Typical Loss vs. Frequency (50 ohm line)

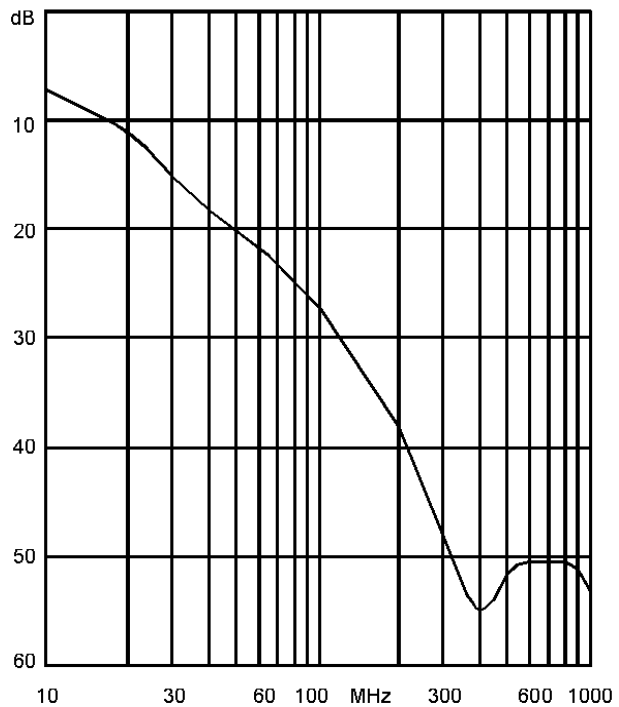

Mating cycles	500
Contacts	Formed Cu alloy
Contact plating	Gold
Shell	Tin-plated steel
Contact resistance ..	max. 10 m Ω
Current rating	3 A
Working voltage	100 Vdc
Capacitance	1 nF
Tolerance	-20 +80%
Temperature	-55 °C to 85 °C

FERROPERM

SUB-D FILTER PLUGS

16 SD 92

An example of a custom design

These SUB-D connectors have built-in feedthrough capacitors which provide excellent attenuation of conducted electromagnetic interference (EMI). The connectors have 15 ways. Pins 13 and 14 do not have capacitors fitted.

To order these connectors, please specify 16 SD 92

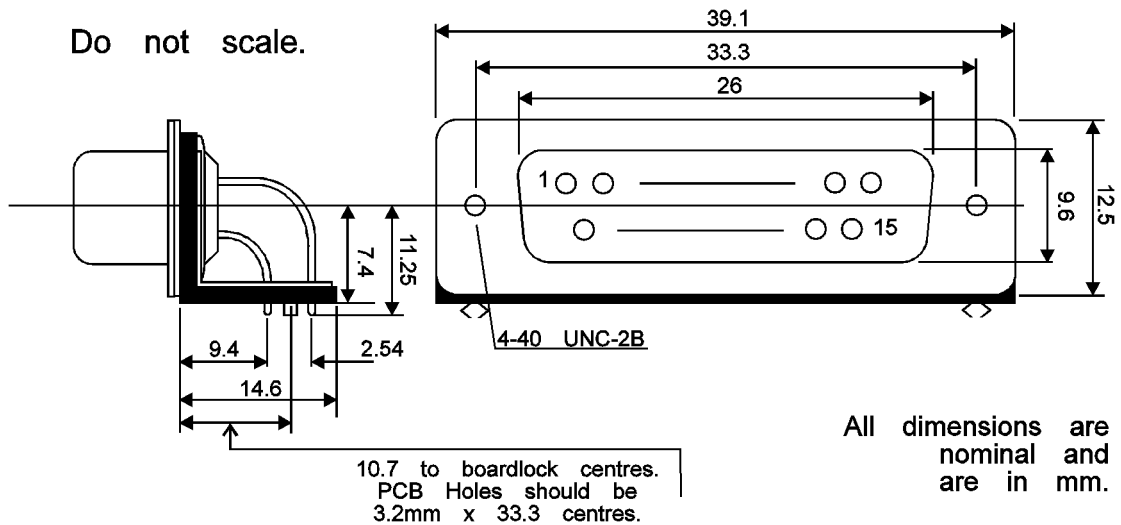

Typical Loss vs. Frequency (50 ohm line)

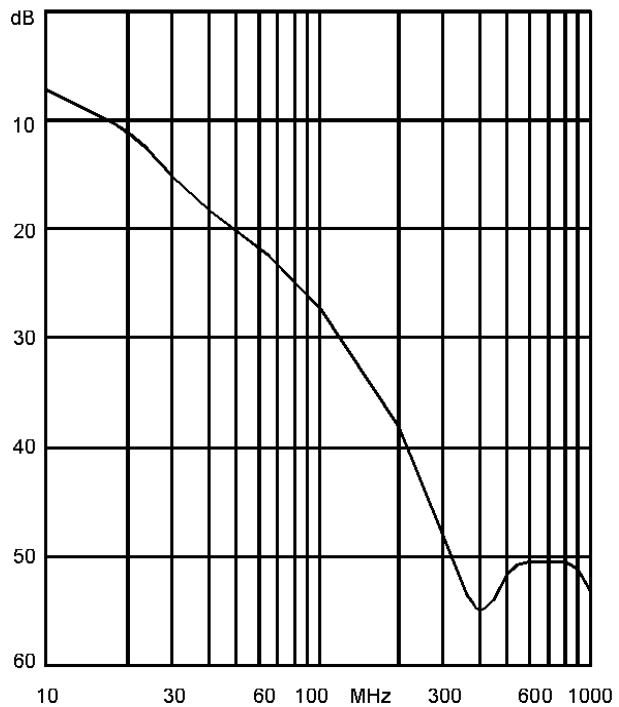

Mating cycles	500
Contacts	machined Cu alloy
Contact plating	0.5 μ gold
Shell	Tin-plated steel
Contact resistance ..	max. 10 m Ω
Current rating	5 A
Working voltage	80 Vdc
Capacitance	1 nF
Fitted to all pins except 13 and 14	
Tolerance	-20 +80%
Temperature	-55 $^{\circ}$ C to 85 $^{\circ}$ C

FERROPERM

The Reliable Source . . .

FERROPERM

*. . . serving the
electronics industry*

Other products from Ferroperm include . . .

- Inductors and chokes
- Small Transformers (all types except 50/60 Hz "mains")
- Soft magnetic Ferrites & Iron Dust Cores
- Hard magnetic Ferrites
- Piezo Electric Ceramics
- Thin Film Optical Interference Filters

FERROPERM's Sub-D Connectors are available from:

FCT Electronic GmbH
Schatzbogen 33
D-81829 Munich
Germany
Tel: +49 89 42 00 04 0
Fax: +49 89 42 00 04 10
E-Mail: sales@fct-electronic.de

Sherwood Electronics Ltd
Pinfold Trading Estate
Nottingham Road
Stapleford, Notts. NG9 8AY. U.K.
Tel: +44 (0)115 939 1095
Fax: +44 (0)115 939 3090
E-Mail: sales@sherwoodelectronics.co.uk

FERROPERM UK LTD.
Vauxhall Industrial Estate,
Ruabon, Wrexham,
Clwyd LL14 6HA.
United Kingdom.
Phone +44 1978 823 990
Fax +44 1978 810 128



Catch us on the web at
<http://www.ferroperm.co.uk>

Email us on
mail@ferroperm.co.uk